

Serie / series / série: **INOXS**

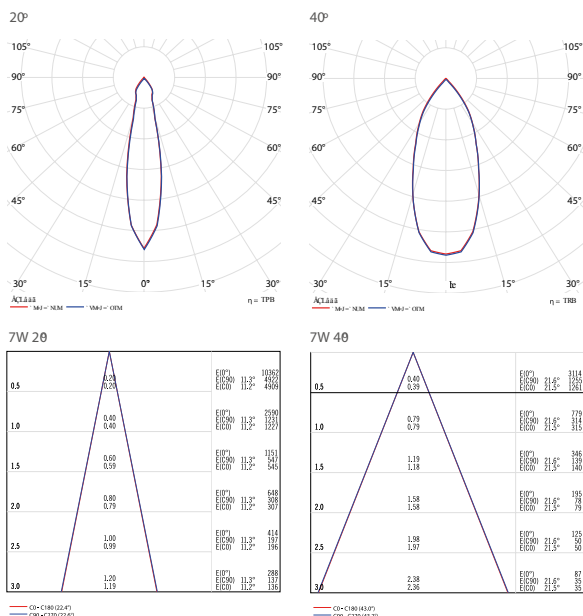
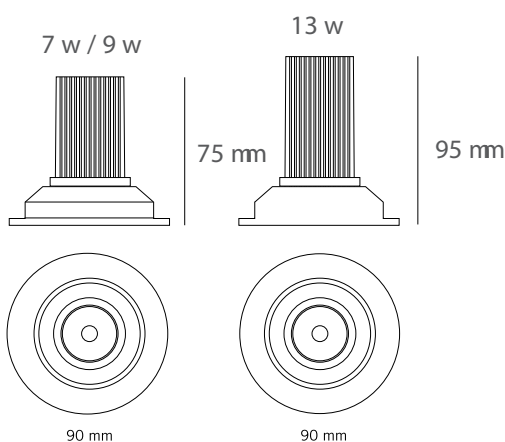

Ref. **00292-XXXXX**

	- 0	- 1	- 8
* Colores:	blanco	negro	aluminio
* Colours:	white	black	aluminum
* Couleurs:	blanc	noir	aluminium
* Temp. color / colour / couleur:	- G 827	- C 830	- N 840
			- H (*) 927
* Ángulo / Angle/ Angle:	- 2 20	- 4 40	- 6 60
* Lámpara / Lamp / Lampe:	- 0 7w 660 lm	- 1 9 w 960 lm	- 2 13 w 1200 lm
* Reg. corte fase / dimmable by edge cut / dimmable per coupe phase:			- R
* DALI: (*)			- D

* Opcional / Optional / En option











DESCRIPCIÓN | DESCRIPTION | DESCRIPTION

Downlight empotrable orientable para lámparas LED 7 / 9 / 13w
Downlight rotatable for LED lamps 7 / 9 / 13w
Spot encastrable pivotant pour lampes 7 / 9 / 13w

INSTALACIÓN | INSTALLATION | INSTALLATION

Empotrable redondo 82 mm
Round embedding 82 mm
Encastración rondé 82 mm

CARACTERÍSTICAS TÉCNICAS | TECHNICAL FEATURES | CARACTÉRISTIQUES TECHNIQUES

320g 82 mm 44 0,5m 10° 1 40.000 h DRIVER 230V LED
CRI > 80 / 90

CERTIFICADOS DE CALIDAD | QUALITY CERTIFICATE | CERTIFICAT DE QUALITÉ



Tel: +34 937 154 712
Fax: +34 937 154 713
www.nexia.es
www.facebook.com/nexialighting
www.twitter.com/nexialighting

FECHA DE ACTUALIZACIÓN / UPDATED ON:
DATE D'ACTUALISATION: **12-07-2016**

Nexia se reserva el derecho de modificar las especificaciones técnicas de sus productos, que sirvan para su mejora y adaptación a las normativas futuras.
Nexia reserves the right to change the technical specifications of their products. These changes will allow the continual improvement of the products and will also ensure the conformity to current legal.
Nexia se réserve le droit de modifier les spécifications techniques de leurs produits, qui sont utilisés en vue de leur amélioration ou à des changements dans les lois.